

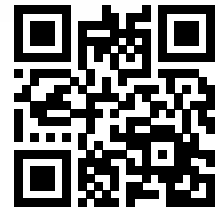





7 SERIES

<http://tiny.cc/7seriesEN>

 TIPPING LOAD 1550* kg	 ENGINE POWER 35* hp	 SPEED 10-20* km/h	 FLOW RATE 68* l/min	 LIFT HEIGHT 2,9 m
---	--	---	---	---

(*) 7.3S

Model	NEW 7.2	7.3	7.3+	7.3S (2 speed)
Engine	Yanmar 3TNV76	Yanmar 3TNV82		
Power (Iso Gross)	28 HP	35 HP		
Fuel	Diesel			
Transmission	Hydrostatic			
Drive speed (max.)	11 km/h (6.8 mph)	15 km/h (9.3 mph)	11 km/h (6.8 mph)	10 - 20 km/h (6.2 - 12.4 mph)
Aux. hydraulics oil flow	37 l/min (9,8 GPM)	68 l/min (17.9 GPM)		
Max. lifting height	2,90 m (114 in)			
Tipping load, max ⁽¹⁾	1500 kg (3307 lbs)	1550 kg (3417 lbs)		
Lifting capacity straight ⁽²⁾	1200 kg (2645 lbs)	1240 kg (2734 lbs)		
Lifting capacity fully articulated ⁽³⁾	1020 kg (2249 lbs)	1070 kg (2360 lbs)		
Breakout force / 50 cm	1700 kg (3748 lbs)			
Pushing force (c)	1690 kgf (1690 kp)	1300 kgf (1300 kp)	1690 kgf (1690 kp)	2000 kgf (2000 kp)
Specific ground pressure (w/standard tires)	1113 kg/m ² (228 lbs/sqft)	1154 kg/m ² (236 lbs/sqft)		1168 kg/m ² (239 lbs/sqft)
Turning radius: inside/outside	825/2090 mm (32.5/82.3 in)			
Standard tires (Tractor profile)	23X10.50-12			
Weight	1610 kg (3549 lbs)	1670 kg (3682 lbs)		1690 kg (3726 lbs)
Product Code	C962015	C962000	C962005	C962010
Price				

Tires size	Width (N)	Height (Q)
23X8.50-12	1070 mm (42.2 in)	2020 mm (79.5 in)
23X10.50-12	1130 mm (44.5 in)	2020 mm (79.5 in)
26X12.00-12	1280 mm (50.4 in)	2040 mm (80.3 in)
27X8.50-15	1070 mm (42.1 in)	2080 mm (81.9 in)
27X10.50-15	1150 mm (45.3 in)	2080 mm (81.9 in)

(1) Maximum load that can be lifted just off the ground when the machine is straight, with back-weights and boom not extended. Weight of attachment included.

(2) Machine straight, with back-weights and boom not extended. Weight of attachment is included. (80% of tipping load).

(3) Machine fully articulated, with back-weights and boom not extended. Weight of attachment is included.

7 SERIES - FEATURES AND OPTIONS

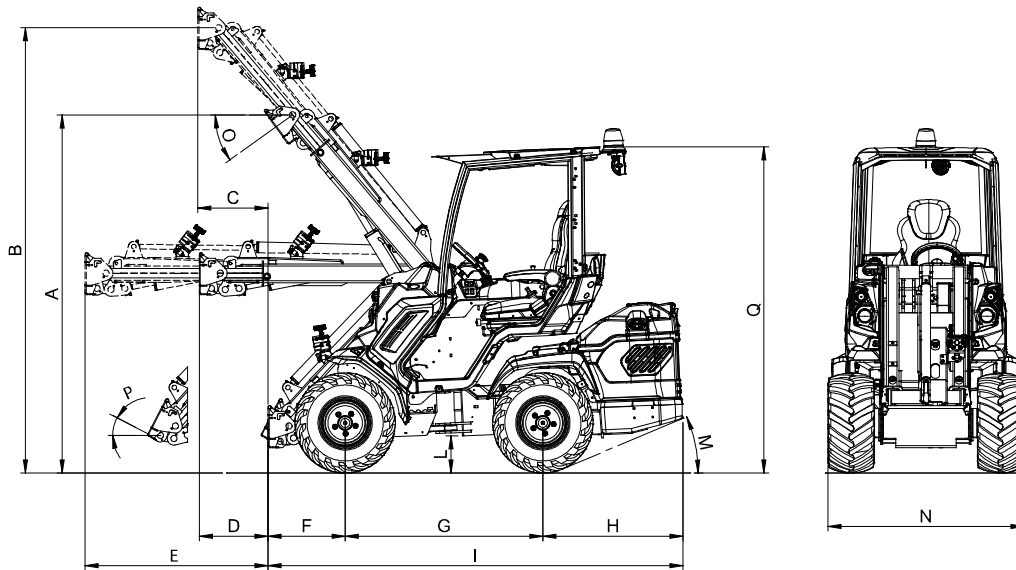

Dimensions (mm / in)

A - Pivot point height (not extended boom)	2280 / 89.7	I - Machine length	2690 / 105.9
B - Pivot point height (extended boom)	2900 / 114	L - Ground clearance	210 / 8.3
C - Outreach with lifted boom (extended boom)	455 / 17.9	M - Angle of departure (with/without back-weights)	20°/21°
D - Outreach with orizontal boom (not extended)	445 / 17.5	N - Max width (with standard tires)	1130 / 44.5
E - Outreach with orizontal boom (extended)	1185 / 46.6	O - Dump angle	36°
F - Front length	500 / 19.7	P - Rollback angle	29°
G - Wheelbase	1280 / 50.4	Q - Height (with standard tires)	2020 / 79.5
H - Rear length	910 / 35.8		

Features

- Hi-Flow system (not available for 7.2)
- 4WD hydrostatic Direct Drive motors
- DBS (Dynamic Block System)
- Torque divider (optional on 7.2)
- Self-levelling double-H telescopic boom
- 11-functions joystick (only 7.3, 7.3+, 7.3S)
- Multi-disk parking brake
- Integrated back-weights
- Radial Piston Wheel Motor
- Hydraulic oil cooler
- Hydraulic multiconnector
- ROPS-FOPS Level I
- LCD graphic display with programmed service (tachometer, hour meter, fuel gauge, maintenance light, light indicator and other 14 indicators)
- 2 front working light
- Ergonomic full adjustable suspension seat with armrests and safety belt.
- 2 speed (only 7.3S)

7 SERIES - FEATURES AND OPTIONS

Options	Code	Price
Attachment coupling plate for rear mounting	C880031	
Driver area cover	C880049	
Additional back-weights 180 kg/396 lbs (90kg/198lbs+90kg/198 lbs)	C880054	
Wheel spacer 10 mm (0.4 in) (max. 1 pcs for wheel)	C880090	
Multiconnector to quick coupling 3 lines adapter	C880221	
Plexiglass windscreen (smart cabin)	C883000	
Fully glass cab with inner clothing	C883001	
Heating system	C883002	
High comfort heated seat	C883006	
Biodegradable oil	C883007	
LED Road lights "Hella" with mirrors	C883009	
Floating boom valve	C883011	
Rear hydraulic outlets - single	C883013	
Rear hydraulic outlets - double	C883014	
3 additional working LED light "Hella"	C883018	
Left protection bar for operator	C883020	
Backup warning beeper	C883021	
Rear 12V electric socket	C883022	
Additional front hydraulic outlets (not available for 7.2)	C883024	
Plexiglass right side (smart cabin)	C883034	
Plexiglass back window (smart cabin)	C883035	
Rear bull bar with side extensions	C883036	
Automatic locking plate	C883038	
Beacon light	C883039	
Multifunction joystick (only 7.2)	C883041	
Torque divider for 7.2	C883600	
Tractor tires 23x8.50-12, set of 4	C884005	
Grass tires 23x8.50-12, set of 4	C884006	
Grass tires 23x10.50-12 ET-25, set of 4	C884008	

7 SERIES - FEATURES AND OPTIONS

Options	Code	Price
Tractor tires 26x12.00-12 ET-50, set of 4	C884009	
Grass tires 26x12.00-12 ET-50, set of 4	C884010	
Skid tires 27x8.50-15, set of 4	C884011	
Skid tires 27x10.50-15, set of 4	C884012	
Wheel spacer 55 mm (2.2 in), set of 4	C885010	
Trailer coupling	C885014	
220 V engine block heater	C885250	
110 V engine block heater	C885255	
Snow chains for wheel	see page 64	

Machine packages	Code	Price
7.2	ALL SEASON: Fully glass cab with inner clothing + Heating system + Floating boom valve	C962015/AS
	COMFORT: High comfort heated seat + 3 additional working LED lights + Floating boom valve	C962015/C
7.3	ALL SEASON: Fully glass cab with inner clothing + Heating system + Floating boom valve	C962000/AS
	COMFORT: High comfort heated seat + 3 additional working LED lights + Floating boom valve	C962000/C
7.3+	ALL SEASON: Fully glass cab with inner clothing + Heating system + Floating boom valve	C962005/AS
	COMFORT: High comfort heated seat + 3 additional working LED lights + Floating boom valve	C962005/C
7.3S	ALL SEASON: Fully glass cab with inner clothing + Heating system + Floating boom valve	C962010/AS
	COMFORT: High comfort heated seat + 3 additional working LED lights + Floating boom valve	C962010/C